

CEIDRAL



The World of Roofs



FIBRE CEMENT SLATES **FIXING GUIDE**



FIBRE CEMENT SLATES FIXING GUIDE

Cedral, a market leader in the design and manufacture of fibre cement roofing products, offers high quality, durable Cedral fibre cement slates in a variety of colours, sizes and textures.

This fixing guide gives comprehensive details on how to install Cedral fibre cement slate roofing products.

CONTENTS

GENERAL ADVICE

- 5 Storage and handling
- 7 Loading out
- 8 Underlays
- 10 Battens
- 12 Cutting slates
- 14 Flashings and weatherings

GENERAL FIXING

- 17 Setting out the roof
- 19 Nail and rivet fixing
- 25 Finishing slates at ridge
- 37 Verges
- 34 Hips
- 37 Valleys

- 39 Ridges
- 42 In-Line Slate Vent
- 46 Large Capacity Slate Vent
- 41 Hook fixing
- 46 Vertical slating

VENTILATION GUIDANCE

- 50 Standards and regulations
- 51 Control of condensation
- 53 Underlays
- 55 Roof types
- 58 Cold roofs
- 62 Warm roofs



General advice

- 5 Storage and handling
- 7 Loading out
- 9 Underlays
- 10 Battens
- 12 Cutting slates
- 14 Flashings and weatherings

Storage and handling

Provision should be made for proper storage and handling of Cedral fibre cement slates to avoid deterioration in quality and appearance, to avoid breakage or distortion and to minimise wastage.

GENERAL

- 1 Should be stored in a safe location and **MUST** be kept from damage on site. Pallets **MUST** be stored on a smooth, level base capable of supporting their weight.
- 2 Slates must not be allowed to become wet when in packs or banded together, as efflorescence and staining can occur.
- 3 Pallets and crates should be transported using appropriate lifting machine such as a fork lift. Unload and handle slates and fittings with care to avoid damage, soiling or breakage.
- 4 Storage inside a building or similar shelter: the polythene hoods covering the slates should remain as a temporary protection to the slates, provided no water vapour can enter from below the packs.
- 5 Storage outside: remove the polythene hoods and stack the slates in bundles off the ground and cover with a good tarpaulin allowing clearance between the tarpaulin and the slates. This will allow free air movement and help prevent condensation forming within the pack (which could cause efflorescence).
- 6 If the slates are to be stored outside for a very short period of time, then the sides of the hood should be split open before covering with a tarpaulin to reduce the risk of condensation in the packs.
- 7 On larger contracts, it is better to avoid storing too many packs on site and to schedule deliveries of slates as they are required.
- 8 Do not stack slates more than 2 pallets high in stockyards or on site.

Storage and handling

HEALTH AND SAFETY GUIDE 33 (HSG33)

The above guide 'Health and safety in roof work' sets out full working at height, handling, public protection, risk assessment and CDM guidance and recommendations and should be referred to before commencing work on any project.

Most Cedral products are provided palletised, banded and shrink wrapped and can be delivered direct to site by a fleet of modern transport with mechanical off-loading facilities.

The products are delivered as follows:

Cedral fibre cement slates - banded, packed on pallets under a cardboard hood and shrink wrapped.



Loading out

GENERAL

- 1 Before slating commences, check delivered products against initial order and report any discrepancies or defective materials to the site agent or manufacturer (BS 8000-6).
- 2 Pallet labels should be checked for correct material and batch codes recorded for future reference.
- 3 Special fittings must be checked against matching slates to ensure suitability before slating commences.

LOADING THE ROOF WITH SLATES

- Load slates and fittings out on roof safely, support by battens to avoid slippage and distribute evenly to prevent overloading of roof structure (Fig. 1).
- All slates must be mixed from different pallet loads whilst the roof is being loaded to prevent the appearance of colour blocking once laid.

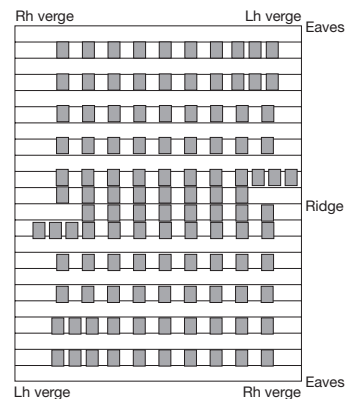

Fig. 1 Loading roof evenly with slate stacks

Underlays

GENERAL

Underlays for use beneath slates are either fully supported over boarding, sheathing or sarking, or unsupported draped over rafters and should meet the following:

- 1 LR† underlay to BS EN 13859-1 Class W1 water penetration classification with third party certification for the use intended.
- 2 HR* underlay to BS EN 13859-1 Class W1 water penetration classification with third party certification for the use intended.
- 3 BS 8747 Class 1F Reinforced Bitumen or Class 5U polyester reinforced bitumen.

† LR (low water vapour resistance) underlay - $< 0.25\text{MN.s/g}$
LR underlays are sometimes referred to as 'vapour permeable' or 'breather'.

* HR (high water vapour resistance) underlay - $> 0.25\text{MN.s/g}$

GENERAL LAYING RECOMMENDATIONS

- 4 Lay specified roofing underlay parallel to eaves or ridge with horizontal overlaps as specified by the manufacturer and the roof specification. Vertical side laps should be 150mm (min).
- 5 Minimise gap at laps resulting from different tautness between underlay courses. Drape in underlay between supports to be no less than 10mm and no greater than 15mm.
- 6 Fix underlay with fixings specified, keeping number of perforations to a minimum.
- 7 Handle and fix underlay with care to ensure no tears or punctures.
- 8 Ensure that underlay does not obstruct flow of air through ventilators located at eaves, ridge or in the main roof.



- 9 Appropriately weather all holes formed in underlays for soil vent pipes, etc.
- 10 Underlay laps should be sealed using proprietary means in accordance with manufacturers' instructions. Where a proprietary sealant is used, its durability should meet the same recommendations as the underlay. Laps in underlay are best covered by a batten and the laps could be adjusted to suit batten positions.
- 11 Contact should be avoided between the underlay and the underside of the slates to prevent the wind uplift load being transmitted to the slates.

TYPICAL MINIMUM HORIZONTAL LAP FOR UNDERLAYS

Rafter pitch	Not fully supported	Fully supported	Vertical laps
$\geq 20^\circ$	150mm	100mm	150mm

BS 5250 and BS 5534 give advice on the installation of underlays

Battens

CHOOSING BATTENS

SLATE BATTENS

- 1 Slate battens must be 50 x 25mm and meet the recommendations stated in BS 5534 in terms of their species, permissible characteristics and defects (knots, fissures and splits, wane, slope of grain, rate of growth, distortion, decay and insect attached, sap stain resin pockets and moisture content), including minimum dimensions and grading requirements.
- 2 To help meet these minimum standards, slate battens delivered to site should be graded with the following printed on the battens (in accordance with the standard):
 - a Name of supplier (the company that graded the roofing battens NOT the company that cut them)
 - b Origin
 - c Grade in accordance with BS 5534
 - d Basic size
 - e Type of preservative
- 3 All slate battens must conform to requirements set out in BS 5534 and must be checked prior to installation. Failure to do so will invalidate warranties, introduce a health and safety hazard on site and could result in the whole roof need relaying if the battens do not conform to these standards.

COUNTER BATTENS

- 4 Counter battens must be 50 x 25mm, although they do not need to be marked or graded if fixed direct to roof rafters. To eliminate the risk of unmarked counter battens being used as slate battens, we strongly recommend all battens (slate or counter) must meet the requirements of BS 5534.

Battens

- 5 When counter battens are used to provide a ventilation gap beneath the slates, there is a potential risk of high levels of moisture, therefore both the counter battens and slate battens must be preservative treated.
- 6 One of the biggest issues with slate battens is under-sizing. To avoid this, there are clear tolerance limits for the minimum depth of the slate batten, which is +3mm/-0mm. Also, slate battens cannot be less than 25mm deep and where the span between supports exceeds 600mm, calculations must be completed to determine their correct dimensions for structural integrity.

RECOMMENDED BATTEN SIZES

Tile type	Basic minimum sizes			
Rafters/supports	up to 450mm span	451 - 600mm span		
	width	depth	width	depth
Cedral fibre cement slates	50	25	50	25

All dimensions subject to re-sawing allowance: width + 3mm depth 0 or + 3mm based on measurement at a reference moisture content of 20%.



Cutting slates



Fig. 2. Cutting fibre cement slate using a scriber

All cutting and drilling of slates should be carried out in well ventilated areas to prevent the inhalation of dust, in accordance with Health and Safety recommendations.

- 1 Slates should be scored using a scribing tool and snapped over a straight edge (Fig. 2), or scribed and cut with a guillotine.
- 2 Slates can also be cut with a manual, hand-held slate cutter. This should always be used when cutting acute angles.
- 3 Do not use an angle grinder or slater's axe for cutting fibre cement slates.

Cutting slates

- 4 Additional fixing holes must be drilled using a standard 4.0mm dia. HSS drill bit. Fixing holes must not be punched.
- 5 Do not cut slates that are laid in situ, particularly open valleys, as this may cause damage to the valley lining, and is also a health and safety hazard.
- 6 Always wear appropriate personal protective equipment when mechanically drilling slates.
- 7 After cutting or drilling slates, remove all dust from the surface to avoid staining.
- 8 Sealing of any cut edges to prevent potential efflorescence staining can be carried but historically it does not happen and no detrimental effects have resulted. All cut edges should be on the outside edge of the slated area. i.e. the verge edge or abutment edge.

Product Data Sheets which comply with the Control of Substance Hazardous to Health (COSHH) regulations are available for all Cedral roofing products.

Please contact our Technical Advisory Team for our product data sheets.

Flashings and weatherings

INTRODUCTION

Whilst lead sheet is the most common material for flashings and weatherings for slated roofs, pre-formed flashings and other lead replacement products are growing in popularity. These represent a much lower material cost and can be installed without the need for specialist tradesmen.

Lead is malleable and can be easily dressed to fit flat slates. BS EN 12588* gives the specification for lead for use in roof flashings and weatherings as summarised in the table.

LEAD SHEET FOR BUILDING PURPOSES – BS EN 12588

Code No.	Colour code	Thickness (mm)	Weight (kg/m ²)	Max. length (mm)	Uses
3	Green	1.32	14.97	1.0	Soakers
4	Blue	1.80	20.41	1.5	Flashings Inclined valley Gutters Saddles
5	Red	2.24	25.40	1.5	Horizontal valley gutters

* BS EN 12588 – ‘Lead and lead alloys. Rolled lead sheet for building purposes’. For further information and guidance on leadwork detailing, please see The Lead Sheet Association website: www.leadsheet.co.uk

The following rules apply when using lead as a flashing and weathering:

- 1 Single pieces should be limited in size (the thinner the piece, the smaller the size) so that natural expansion and contraction is kept to a minimum and the risk of severe distortion (with associated risks of fatigue cracking) is avoided.

Flashings and weatherings

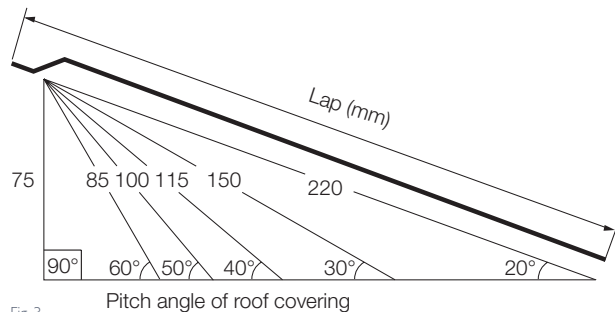

Fig. 3

- 2 Fixings (while not restricting thermal movement) must be adequate to support the lead and (dependent on exposure) retain it in position.
- 3 Joints must allow for thermal movement, yet remain weathertight for the location in which they are used.

Flashings at the head of slated roofs should lap the top course of slates by a distance which will vary according to the pitch of the roof (see Fig. 3).

- 4 All lead flashings and soakers should be treated on all sides with patination oil to prevent water run-off and moisture-containing lead oxide from staining the roof covering.

Flashings and weatherings may also be formed from copper; aluminium or zinc as prescribed in BS 5534.

Proprietary materials formed using GRP, PVC or colour coated aluminium should be fixed in accordance with the manufacturer's recommendations.



General fixing

17 Setting out the roof

19 Nail and rivet fixing

24 Finishing slates at ridge
or top abutment

27 Verges

34 Hips

37 Valleys

39 Ridges

41 Hook fixing

42 In-Line Slate Vent

44 Large Capacity Vent

49 Vertical slating

Setting out the roof

SETTING OUT OF BATTENS

- Roofs should be set out with slate battens, to the appropriate gauge. Select the appropriate gauge for the slate size by using the formula:

$$\text{gauge} = \frac{\text{length of slate} - \text{lap required}}{2}$$

- Allow the eaves slates to overhang into the gutter by approximately 50mm.
- Verge overhang should be restricted to a maximum of 50mm.
- Where less than 3/4 of a standard slate is required, a cut double is used and drilled as required in place of this part slate and the next full slate alongside.
- A vertical or raking batten is advisable at hips, valleys and intersections.



Setting out the roof

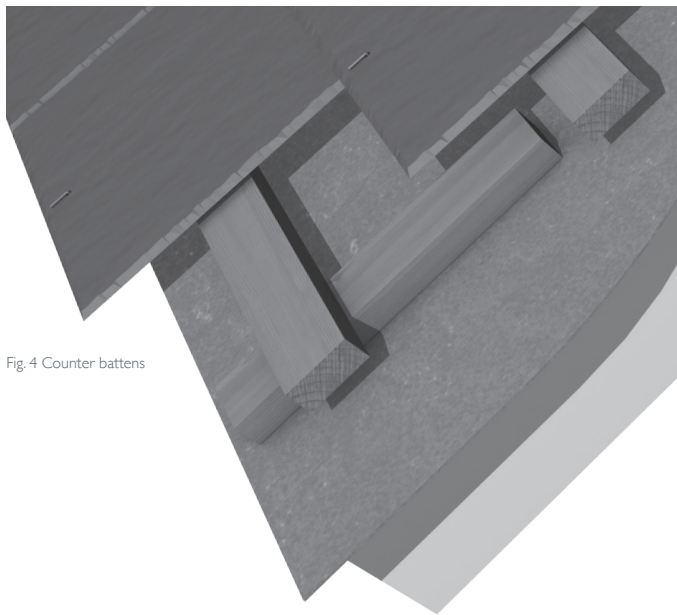

Fig. 4 Counter battens

COUNTER BATTENS

Cedral fibre cement slates are classed as a 'close fitting' roof covering. When installed with vapour permeable underlays, counter battens must be used to ensure 50mm continuous ventilation into the batten cavity along with 25,000mm²/m ventilation at the eaves and 5,000mm²/m at either side of the ridge or at high level.

Nail and rivet fixing

WITH TYPE LR (BREATHER) MEMBRANE BASED ON 600 X 300MM SLATES AT 100MM LAP

- 1 Fix rafter roll over rafters to cover the full depth of insulation to be laid over the ceilings.
- 2 Fix eaves support trays along eaves. Ensure fascias are at the correct level. The correct level is achieved by placing a counter batten and a slate batten, with one thickness of fibre cement slate, on the rafter and the top of the over fascia vent should be touching the projected line from the top of the slate, as described above.
- 3 Fix type LR breather membrane parallel to the eaves and starting at the eaves. The membrane sits over the eaves support trays. Ensure all horizontal joints in the membrane are lapped according to the requirements of BS 5534 for the pitch of the roof. All horizontal joints should be sealed using the adhesive strips incorporated on the membrane.

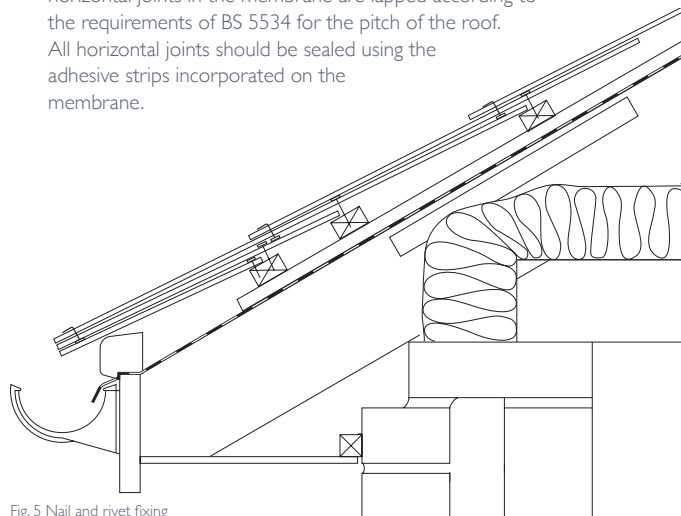

Fig. 5 Nail and rivet fixing

Nail and rivet fixing (LR)

- Fix 25mm over fascia ventilation units on to the top of the fascia boards through the breather membrane and eaves support trays.
- Fix 50 x 25mm treated counter battens over the breather membrane into the rafters starting the batten approx 50mm from the over fascia ventilation units.
- Set out both under-eaves battens to accommodate the under eaves slate lengths as shown in the table below and Fig. 6 below by allowing a maximum of 50mm overhang of the slate beyond the face of the fascia.
- From the top edge of the second batten fix slate battens at intervals equal to the gauge as calculated using the formula on page 17.

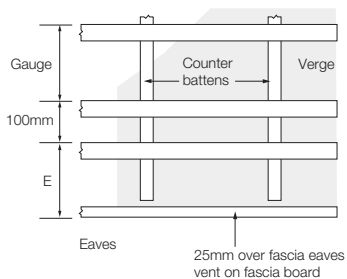

Fig. 6 Batten configuration at eaves.
 $E = A - 25\text{mm}$ ('A' as in table below)

UNDER-EAVES SLATE LENGTHS

All sizes are in mm	Slate size	Typical laps	1st under-eaves slate length (A)	2nd under-eaves slate length (B)
All slate types (22.5 - 90°)	600 x 300	100	250	350
All slate types (20-90°)	600 x 300	110	245	355
All slate types (20-90°)	600 x 300	150	225	375
Thrutone Smooth (22.5 - 90°)	500 x 250	100	200	300

Nail and rivet fixing (LR)

- Begin laying the slates by cutting and head nailing the first under eaves course along the eaves (Fig. 7). Drill two 4mm dia. holes for nails 20mm from each edge and 15mm down from the head of the slate. The head of the slate is placed at the centre of the first batten and a 4-5mm gap should be left between each slate. An offset of slate can be used as a spacer.
- Cut and fix the second under eaves course to the lower batten starting with a slate-and-a-half at the verge (Fig. 8). Prior to fixing the slate-and-a-half, drill a 4mm dia. hole half a slate width in from the verge and 25mm up from the bottom edge, and insert a copper disc rivet for fixing the verge slate of the first full slate course.

Three nail holes will also need to be drilled (4mm dia.) to align with the exposed top half of the first batten. Leave a 4-5mm gap between adjacent slates.

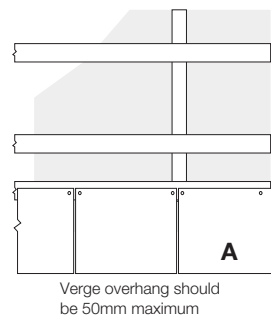

Fig. 7 1st under eaves course

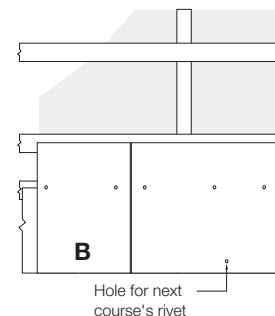

Fig. 8 2nd under eaves course

Nail and rivet fixing (LR)

- 10 Fix the first course of full size slates. At the verge another 4mm dia. hole is required to allow for the copper disc rivet for the course above. This is drilled 50mm from the verge edge of the slate and 25mm, plus gauge, from the bottom edge of the slate or tail (Fig. 9). The rivet must be inserted before nailing the slate in position.
- 11 Each full size slate is now fixed with two nails firmly into the slate batten and a rivet is placed between the edges of the slates in the course bow (Fig. 10) and the shank of the rivet projects through the hole in the tail of the appropriate slate in the course above. The shank of the rivet is now bent down slope once the slate is fully nailed, which secures the tail of the slate. Leave a 4-5mm gap between adjacent slates.

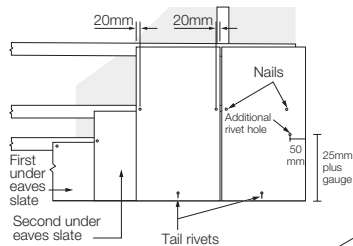

Fig. 9 – 1st course of full slates

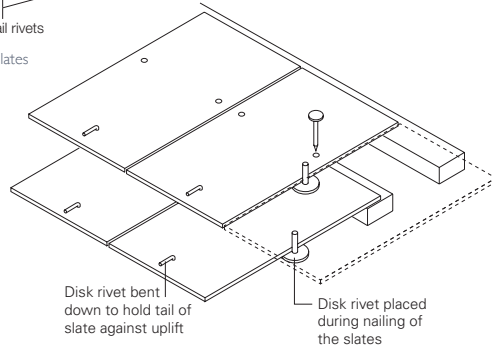

Fig. 10 Rivet placement

Nail and rivet fixing (LR)

- 12 At the verge the next course starts with a full length slate and a half, drilling 3 x 4mm dia. holes for nails on the batten line and two additional 4mm dia. holes for the copper disc rivets (Fig. 11). A third 4mm dia. hole is required for the tail rivet of the course above at point C, (see Fig. 11), this is drilled half a slate width from the verge edge side of the slate and 25mm, plus gauge, from the bottom edge or tail of the slate.

For the remaining courses at the verge, alternate between standard single slate and the slate and a half.

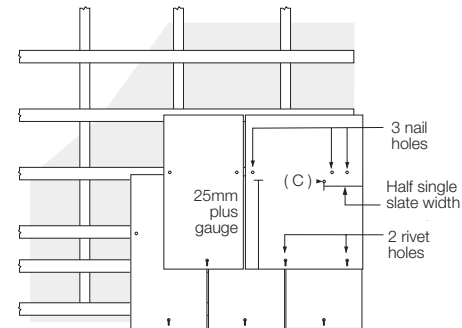

Fig. 11 Using slate-and-a-half to break bond

Nail and rivet fixing (LR)

- 13 Continue across and up the roof with whole slates, trimming to verges, hips, valley and ridges as necessary (Fig. 12).

Cut double slates must be used at hips and valleys. The minimum width of cut slate should be 3/4 of a standard slate. If less, we advise using a cut double slate in place of the small cut piece and the adjacent full slate.

Remember to leave a 4-5mm gap between adjacent slates and that an offcut of slate can be used as a spacer. (Slate is 4mm thick).

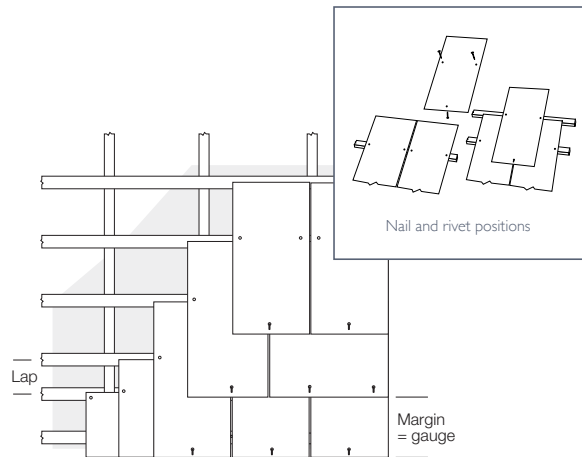

Fig. 12 Continue laying broken bond

Finishing slates at ridge or top abutment

- 1 Continue fixing slate battens at gauge until ridge to top abutment is reached.
- 2 Unless the last slate batten is at the apex of the counter battens or top abutment minus 10mm, fix another slate batten at this location.
- 3 Ensure that a slate batten is at the position required for the fibre cement ridge fixing. If not place another batten at the position required (normally just below the top batten but pitch can vary this).
- 4 Continue slating until the last full course can be laid.
- 5 The next course of slates will need the top of the slate trimmed to match the top of the top batten. This course of slates should be able to be fixed using the pre form fixing holes.
- 6 Next check that when the fibre cement ridge is laid in place what length of slate of the last course is showing. If this is greater than the gauge of the slates another cut course of slates will be required. This slate will need drilling to the top batten for head nailing. Drill two 4mm dia. holes 25mm down from the top edge and 30mm in from each edge. These hole positions will also need drilling through the slates already installed.
- 7 The roof is now ready to install the ridge (see page 39).

Finishing slates at ridge or top abutment

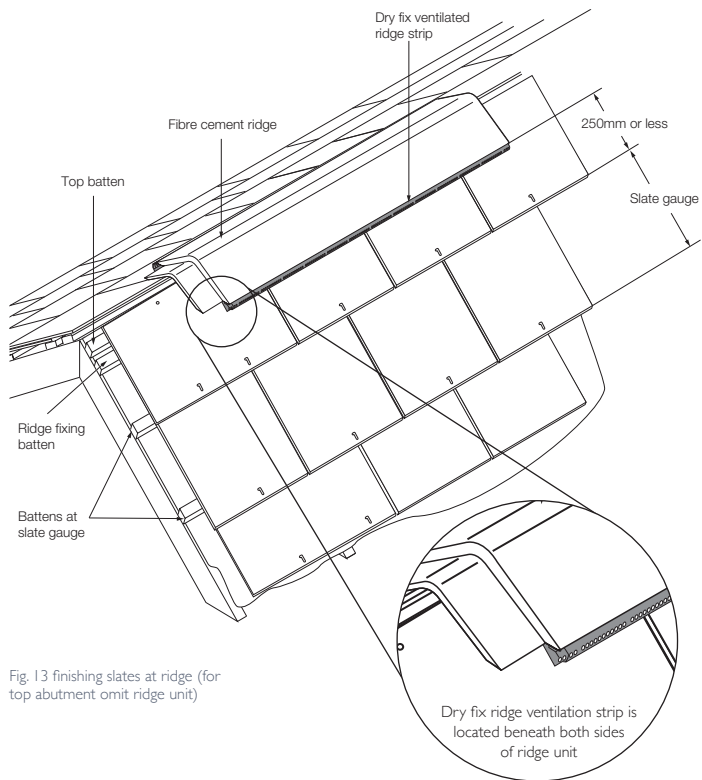
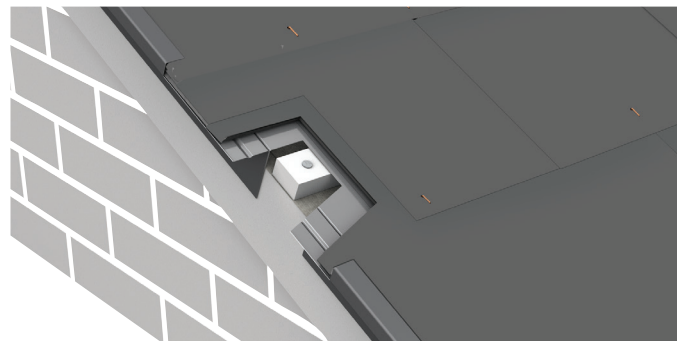

Fig. 13 finishing slates at ridge (for top abutment omit ridge unit)

Slate verge trims

ST1, ST2 and ST3



These aluminium slate verge trims provide the benefits of a dry verge for Cedral fibre cement slates. The trims can be used with or without bargeboard.



ST1 SLATE
VERGE TRIM

3050mm long,
New Roofs

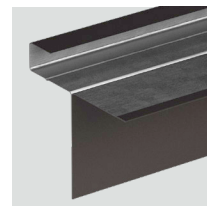

ST2 SLATE
VERGE TRIM

3050mm long,
Flush Gables



ST3 SLATE
VERGE TRIM

3050mm long,
Existing Roofs

STI slate verge trim

- 1 Underlay and battens should be laid and cut flush with inner edge of bargeboard or 50mm back from outside edge of gable wall when a bargeboard is not present.
- 2 Position the verge trim on top of the battens and barge board to desired overhang.
- 3 Position the first length to overhang at the eaves into the gutter by the required amount equal to overhang of slates.
- 4 Nail horizontal flange of the trim to each batten or bargeboard as appropriate using a 25mm long galvanised clout nail ensuring the batten ends are nailed to the substructure.

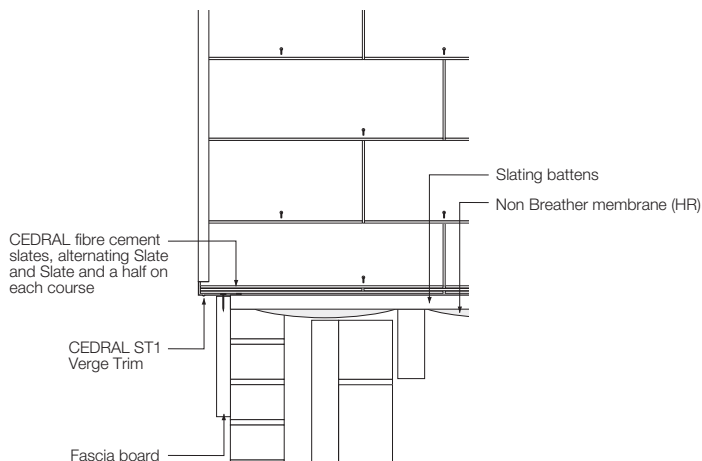

Fig. 14 STI trim

STI slate verge trim

- 5 If additional lengths need to be joined, ensure the joint is on a slate batten.
- 6 Before fully fixing the lower length a cut/slot need to be formed to the length of the lap (suggested lap 50mm / width of batten) at the corner of lower flange and vertical outside edge on vertical side of the corner; remove welt to inside edge equal to the lap.
- 7 Locate end of upper section such that the horizontal flange sits on top of the lower section horizontal flange and passes through the slot on the outside corner of the lower section. This should result in the vertical and upper flange of the top section be over the lower section.
- 8 Ensure the two sections are pushed firmly together and ensure both sections are fixed firmly to the batten underneath.
- 9 Process can be repeated until the ridge line is reached. Then if a stop end ridge is used the trims from each elevation can be butted together as joint shall be covered.
- 10 Slide the verge slates under the lip of the verge trim and fix in accordance with the recommended specification.
- 11 If the upper leg is to form part of the ridge joint, carry out the apex cutting process prior to nailing to batten.**
- 12 Please note that sheet metal cutters should always be used to cut the trim, use protective gloves when handling to avoid injury from sharp edges.**

ST2 slate verge trim

- 1 Underlay and battens should be laid and cut flush with outer edge of gable wall or bargeboard.
- 2 Position the verge trim on top of the battens and align the vertical leg against the batten ends or gable wall.
- 3 Position the first length to overhang at the eaves into the gutter by the required amount equal to overhang of slates. Remove part of the downstand to the fascia line.
- 4 Nail horizontal flange of the trim to each batten using a 25mm long galvanised clout nail ensuring the batten ends are nailed to the substructure.
- 5 If additional lengths need to be joined, ensure the joint is on a slate batten.
- 6 Before fully fixing the lower length a cut/slot need to be formed alongside the downstand on the outer side equal to the length of the lap (suggested lap 50mm / width of batten) make a 2nd cut / slot need to be formed at corner of lower flange and vertical outside edge on vertical side of the corner; remove welt to inside edge equal to the lap.
- 7 Locate end of upper section such that the horizontal flange sits on top of the lower section horizontal flange and the downstand of the upper section locates in the slot of the lower section on outside of downstand. Outside of lower section passed through the slot on the outside corner of the lower section. This should result in the vertical and upper flange of the top section be over the lower section.
- 8 Ensure the two section are pushed firmly together and ensure both sections are fixed firmly to the batten underneath.
- 9 Process can be repeated until the ridge line is reached.

ST2 slate verge trim

- 10 Slide the verge slates under the lip of the verge trim and fix in accordance with the recommended specification.
- 11 **If the upper leg is to form part of the ridge joint, carry out the apex cutting process prior to nailing to batten.**
- 12 **Please note that sheet metal cutters should always be used to cut the trim, use protective gloves when handling to avoid injury from sharp edges**

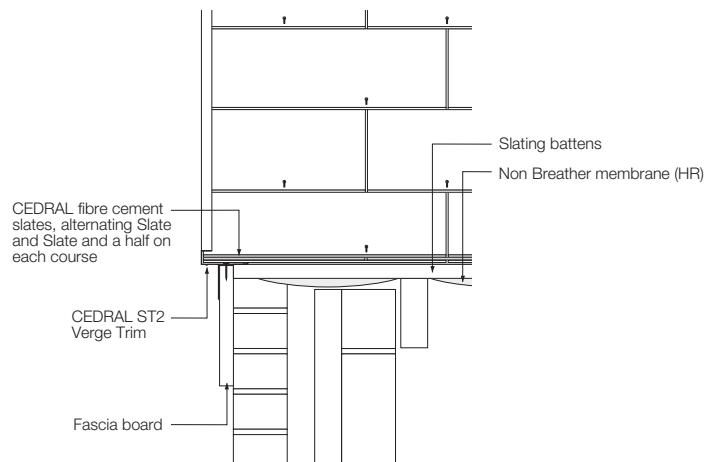

Fig. 15 ST2 trim

ST3 Retrofit trim

ST3 is a retrofit trim for use where over-hang from fascia or gable consists only of slates.

- 1 Position the verge trim over the slates and check whether a makeup batten is required at the bargeboard or gable wall.
- 2 Install makeup batten if required so bottom edge of makeup batten is 15mm short of trim edge.
- 3 Position the first length to overhang at the eaves into the gutter by the required amount equal to overhang of slates. Remove part of the downstand to the fascia line.

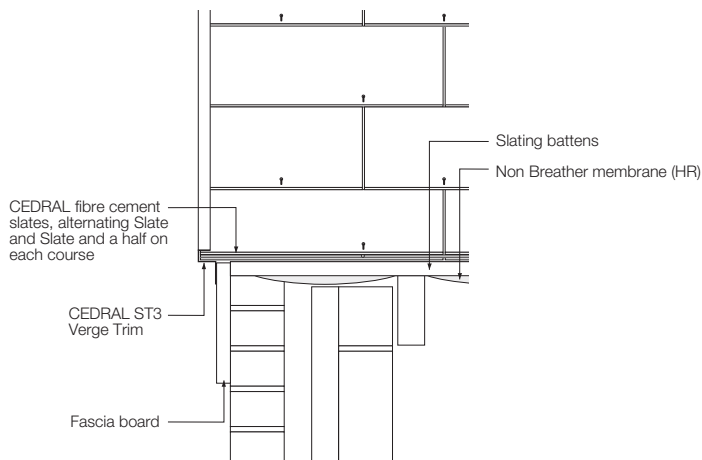

Fig. I6 ST3 trim

ST3 Retrofit trim

- 4 Fix with appropriate fixings (Colour head screws) vertical downstand of the trim to make up batten / bargeboard / gable wall at maximum 600mm fixing centres.
- 5 If additional lengths need to be joined, Before fully fixing the lower length a cut/slot need to be formed alongside the downstand on the outside edge equal to the length of the lap suggested lap 50mm make a 2nd cut /slot need to be formed at corner of lower flange and vertical outside edge on vertical side of the corner.
- 6 Locate end of upper section such that the horizontal flange sits on top of the lower section horizontal flange and the downstand of the upper section locates in the slot of the lower section on outside of downstand. Outside of lower section passed through the slot on the outside corner of the lower section. This should result in the vertical and upper flange of the top section be over the lower section.
- 7 Ensure the two section are pushed firmly together and ensure both sections are fixed firmly as per point 4.
- 8 Process can be repeated until the ridge line is reached.
- 9 If ridge is retained cut verge trim neatly to meet installed ridges.
- 10 Please note that sheet metal cutters should always be used to cut the trim, use protective gloves when handling to avoid injury from sharp edges.

Hips

HIPS WITH CEDRAL FIBRE CEMENT FIBRE CEMENT RIDGES

Cedral fibre cement ridges can be used to cap hips as well as roof apexes.

- 1 Dress the underlay along each slope and end at the hip rafter: Dress additional underlay along the hip rafter, overlapping 300mm minimum each side.
- 2 Fix a 150 x 25mm hip board on each side of the rafter on top of the counter battens. Cut and nail slate battens into side of hip board.
- 3 Mitred slates cut from double blanks should be fixed to the battens and hip boards. Each raking cut slate should be site drilled with 3 nail holes and 2 rivet holes, plus an additional rivet hole for the next course above if required.

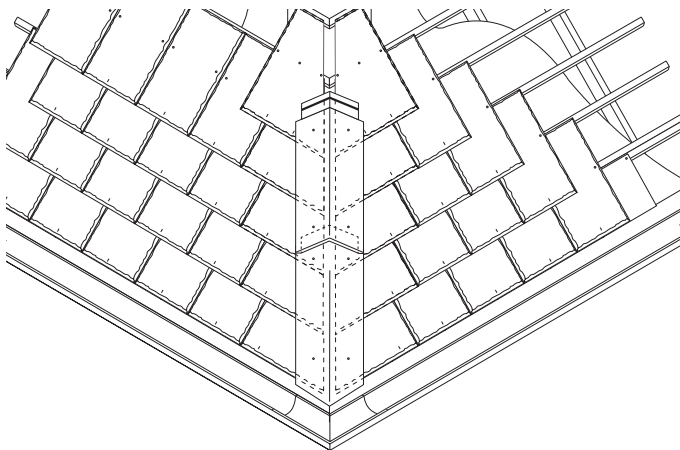

Fig. 17 Cedral fibre cement fibre cement ridge units used as hip capping

Hips



- 4 Place fibre cement unit over hip, with internal socket pointing upwards and cut bottom edge to suit angle of the eaves. Drill 8mm holes (125mm from the effective ends of the capping, 50mm up from the edges) through the hip capping and the slates. Fix capping with 4 No. 60mm x 6.3mm self-sealing screws into the hip boards.
- 5 Fix subsequent units up the hip, sealing the joints with 6mm diameter butyl strip (Fig. 17, page 34).
- 6 At the intersection of the hips and ridge, all the fibre cement cappings should be mitre cut to form a neat detail with tight joints. The whole junction should be weathered with a Code 4 lead saddle fitted beneath the cappings. To avoid lead oxide staining, patination oil should be applied to all the lead surfaces before fixing.

Note: The use of additional extra wide slates may be necessary adjacent to the mitre-cut slates to reinstate the slate bond sequence across the roof.

Close mitred hips

Close mitred hip constructions should not be used for roof pitches below 30°.

If the site is in an exposed location, additional fixings are required.

- 1 Dress underlay along each slope and cut at the hip rafter. Dress additional underlay along the hip rafter, overlapping 300mm minimum on each side.
- 2 Fix slate battens onto the counter battens trimming and fixing the ends to the hip rafter and align on each slope. Insert lead soakers in every course up the hip (Fig. 18).

Mitred slates cut from double blank units must be fixed with three copper nails and two copper disc rivets.

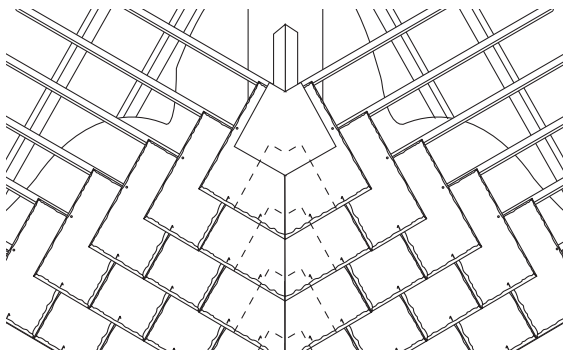

Fig. 18 Close mitred hip with lead soakers

In areas of severe exposure, a supplementary fixing in addition to the above should be used in accordance with BS 5534.

This would require a hip board of 150 x 25mm fixed either side of the hip rafter and the roofing battens cut and fixed to the side of the hip boards.

Valleys

OPEN METAL VALLEY

- 1 Fix support noggin to the inside of each rafter face at a level to receive individual valley boards between the rafters.
- 2 Nail valley boards to lay flush with the tops of the rafters, fix 50 x 47mm valley fillets onto rafters/valley boards (there should be a minimum of 50 mm of valley boards outside of the valley fillets for the slating battens to be fixed to) ensuring sufficient valley width.
- 3 Drape the underlay over the rafters and then fix counter battens at each rafter position stopping 25mm short of the valley fillets. Ensure the underlay is tight to the side of the valley fillets and lays across the top of the fillets.
- 4 Fix slate battens to the counter battens such that they are trimmed to butt against the valley fillets, the ends of the battens may need a support piece of batten fixed to the valley boards but ensure this is kept 25mm away from the valley fillets and is not continuous between counter battens so the water drainage path is not restricted.

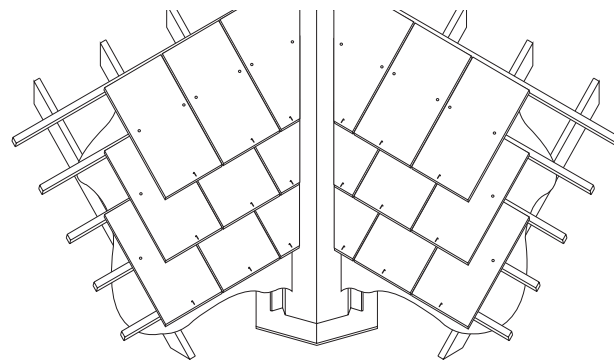

Fig. 19 Open metal valley

Valleys

- Lift the underlay and fix the lead valley gutter lining over the valley boards and dress onto the valley fillets. Form welted edges on the sides of the valley gutter lead lining, reposition the underlay over the welted edges and trim this underlay 40mm beyond the fillets towards the centre of the valley.
- Centre-nail valley slates, positioning rivets before fixing down. Ensure a 50mm overhang from the valley fillet and provide the required clear gutter to maintain an uninterrupted flow of water from the roof (Fig. 19, page 37).

Note: Double width slates should be used in every course adjacent to the valley with additional nail fixings.

MINIMUM WIDTHS OF VALLEY GUTTER

For different roof pitches and plan areas (lead or GRP open valleys)

Design rainfall rate	225mm/h		150mm/h		75mm/h	
Roof pitch (on plan)	<25m ² (mm)	25-100m ² (mm)	<25m ² (mm)	25-100m ² (mm)	<25m ² (mm)	25-100m ² (mm)
20° - 22.5°	125	200	125	150	100	125
22.5° - 29.5°	100	150	100	125	100	100
30° - 34.5°	100	125	100	100	100	100
> 35°	100	100	100	100	100	100

Ridges

FIBRE CEMENT DRY FIXED RIDGE

Cedral fibre cement ridge units and stop ends are designed with a socket for a simple fix by drilling and screwing to an additional ridge fixing batten at the apex. Fixing screws (with colour matched heads suitable for a hex spanner) are 60mm x 6.3mm self-sealing wood screws. An alkali-resisting, non-oil based 6mm diameter butyl strip should be used to seal across the socket, 50mm from the end of the socket.

- Fix the underlay along the roof apex to overlap opposite roof slopes by 300mm.
- Fix slate batten to suit the gauge of the slate as per finishing slating up to ridge, page 26.
- Ensure an additional slate batten is at the position to enable the self-sealing screw of the ridge unit (50mm up from the bottom edge the unit) to screw into.
- Locate a Dry fix ventilated ridge strip and Cedral Fibre cement ridge to the apex, then mark along ridge slates where vents will be sited. Remove protective layer from the double-sided tape, position first ventilated strip and seal to the slates. The Dry fix ventilated ridge strip comes with a pin and hole to attach subsequent ventilated strips along the ridge, this will be repeated for both slopes. Site the Fibre cement ridge on top of the ventilation strip, drill through ridge unit into the additional ridge batten at the apex. The ridge cap ends are available in 45° 37.5° 30° & 22.5° these are then drilled and screwed to additional ridge battens.
- Unless Dry fix ventilated ridge strip are used, start by locating the ridge stop end at one end, drill and screw the ridge to the ridge fix battens. Drill 125mm from the effective ends (i.e. ignore the socket), 50mm up from the bottom edge through the ridge unit and the slates below.
- Screw 4 no. fixing screws through the pre-drilled holes and into the slate batten until screws are firm against the ridge unit.

Ridges

- 7 Apply 6mm butyl diameter strip across the socket, 50mm from the end of the socket.
- 8 Locate successive ridge units along the roof apex, drill and screw to the ridge fixing battens, ensuring a level ridge with joints bedded on butyl strip (Fig. 20).

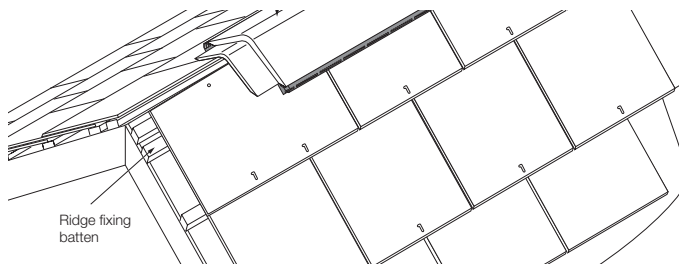

Fig. 20 Ridge finished with fibre cement ridge units – The fibre cement right angle return units are fixed in the standard manner, drilled and screwed and bedded on butyl strip as described above
NB: Please ensure ventilation is always maintained in line with BS 5250

- 9 Shorten one or more ridge units (do not cut off the socket end) to allow finishing the ridge run with a full length stop end (which will require removal of the socket from the stop end unit). Avoid ridge units less than 450mm length. Do not shorten the stop end units.

For fixing fibre cement ridges, a 12-sided (1/4") Torx socket is required.

- 10 A Cedral end cap can be used to neatly terminate the ridge line.

Fibre cement ridge units cannot be mortar bedded.



Hook fixing

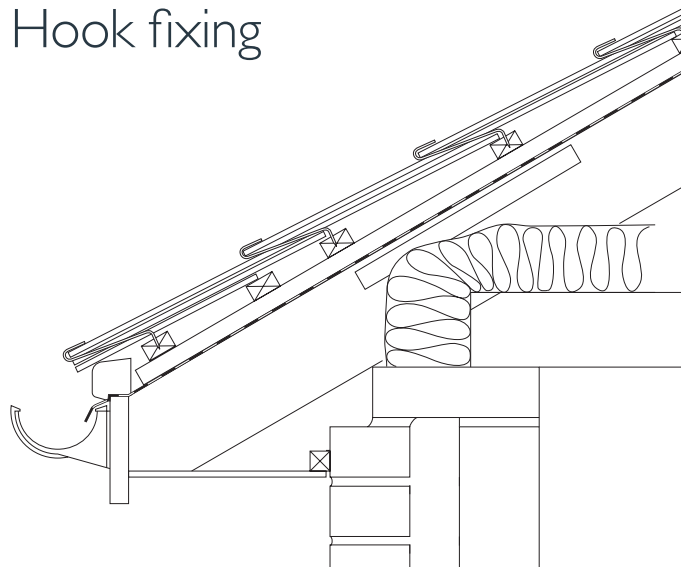

For Hook Fixing information, please contact our technical department:

Tel 01283 501505

Email techuk@etexgroup.com

In-line slate vent

Cedral's In-line slate vent can be used with fibre cement slates and is available in 600 × 300mm and 500 × 250mm sizes.

600 × 300mm minimum pitch 25°, maximum pitch 75°.

500 × 250mm minimum pitch 30°, maximum pitch 75°.



In-line slate vent

FIXING

- 1 Complete the slating in the normal manner to one course below the required position for the slate vent.
- 2 Temporarily fix slates directly below vent.
- 3 Mark the position of the vent on the slates. The vent should be as central between the rafters as practical.
- 4 Remove temporarily fixed slates.
- 5 Cut underlay in a "V" shape as shown. Fold back cut edges of underlay.

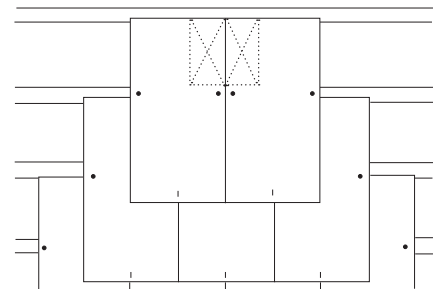

Fig. 21 Marking out

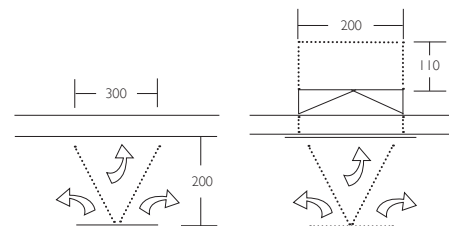

Fig. 22 Making the aperture

In-line slate vent

A Cedral Felt Weir is available. This felt weir will give additional protection to the underlay cut. Neatly cut a 260mm long slot in underlay, at a distance of approx. 60mm above top of the slating batten. Slide the felt weir through this slot until the upstand of the felt weir is up to the bottom of the batten. Allow a minimum cover of 110mm between the felt weir and the underlay. Secure the felt weir by folding the top section of cut underlay over the batten and fix in place with a 20mm galvanised clout nail to the face or back edge of the batten.

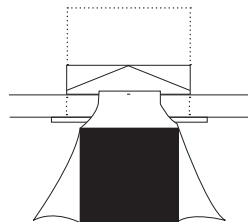

Fig. 23 Cedral Felt Weir

Cut out the top corner of the 2 slates in the course immediately below where the vent outlet is required to be positioned in the roof void. The dimensions of the piece of slate removed should be 190mm x 115mm, as shown. Re-hole the slates as necessary to ensure they can be fixed correctly to the slating battens.

Insert the ventilator into the roof void and secure with slating nails into the batten, ensuring that the vent sits closely onto the -slates below.

The vent is designed for use with 25mm slating battens. Where a thicker batten is used then the back of the batten will need to be reduced to 25mm where it passes across the installed vent. Where the thickness of the slates on either side of the vent is greater than 8mm, then the same trimming of the batten may be necessary.

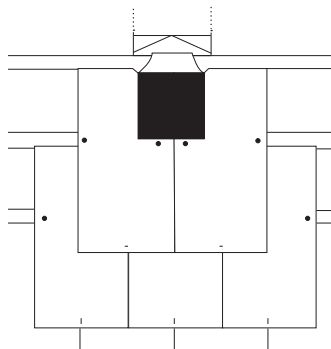

Fig. 24 Trim slates

In-line slate vent

Fix the slates on either side of the vent and then cut and fit a piece of the slate to fit between the top of the grill and the finished line of the slating in the batten above (approx. 300mm). Cut a piece of the same slate 110mm in length to fit the bottom of the vent. Ensure that this piece of slate is dry and free from dust or loose material. Remove the paper covering the butyl strips and stick the slate in place. Ensure the top edge fits under the front edge of the grill and the bottom edge of the slate is flush with the vent slate.

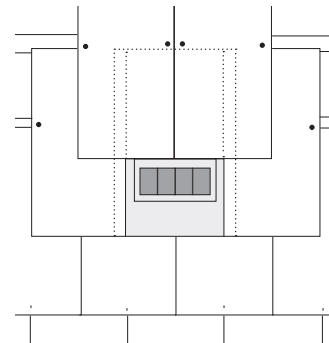

Fig. 25 Position In-Line Slate Vent

If the degree of exposure of the site, or the location of the vent on the roof, gives cause for concern with regard to the security of the bottom edge of the vent, it may be further secured either by using a nail point slate hook or a copper disc rivet inserted through the hole provided. Additionally there is provision to secure the underside of the vent to the slating batten inside the roof void. This could be desirable if a particularly long or heavy flexible pipe is attached to the vent, which might cause it to deform.

Any water entering the vent will drain from the space between the bottom edge of the vent and the cut slate.

Contact Cedral's Technical Support Department for detailed information on ventilation principles and design requirements.

SPECIFICATION

- Size: To suit 600 x 300mm slates & 500 x 250mm slates.
- Capacity: 10,000mm² free air flow
- Outlet: 110mm

Large capacity slate vent

Cedral's Large capacity slate vent is available in 600 x 300mm and can be used with fibre cement slates. Minimum pitch 20°, maximum pitch 45°.



- 1 Complete the slating in the normal manner to one course below the required position for the slate vent.

Temporarily fix slates directly below vent.

Mark the position of the vent on the slates. The vent should be as central between the rafters as practical.

Remove temporarily fixed slates.

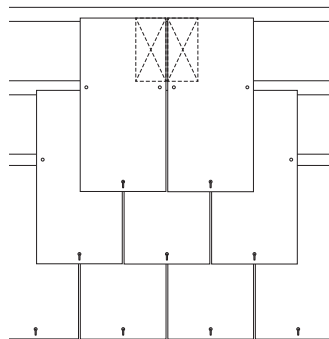

Fig. 26 Marking out

Large capacity slate vent

- 2 Cut underlay in a "V" shape as shown. Fold back cut edges of underlay.

A Cedral Felt Weir is available. This Felt Weir will give additional protection to the underlay cut. Neatly cut a 260mm long slot in underlay, at a distance of approx. 60mm above top of the slating batten. Slide the felt weir through this slot until the upstand of the felt weir is up to the bottom of the batten.

Allow a minimum cover of 110mm between the felt weir and the underlay.

Secure the felt weir by folding the top section of cut underlay over the batten and fix in place with a 20mm galvanised clout nail to the face or back edge of the batten.

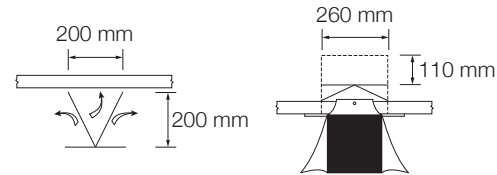

Fig. 27 Making the aperture

- 3 Cut the two slates, which will be under the vent slate to give the required clear air space. The amount to be cut from these slates will vary according to the size of the slate, the lap and gauge of the slating.

For a 600 x 300mm slate laid with a 110mm headlap, the size of this cut is to be 110 x 210mm to each slate.

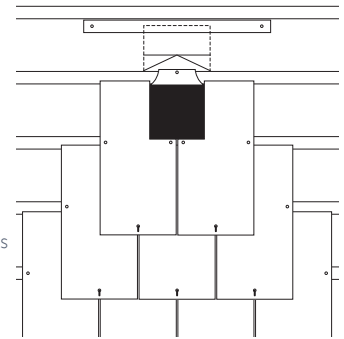

Fig. 28 Trim slates

Large capacity slate vent

Secure an additional batten just below the top of the vent. This batten is to span across the rafters to each side of the vent slate. This additional batten is to receive the vent slate fixings.

Carefully reposition the two cut slates.

- 4 Position the vent slate. Drill two 4.5mm holes in the vent slate, centred on the slating batten and fix to batten through the nail holes provided.

Trim the slates to next course above vent slate to fit neatly around vent slate cowl.

Complete slating in normal manner.

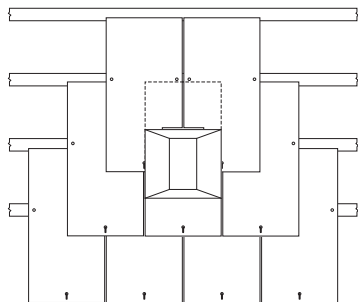

Fig. 29 Position Large Capacity Vent

Vertical slating

For small areas of wall slating (e.g. dormers). In general, vertical slating follows the same installation principles as roof slating (Fig. 30).

- 1 Finish the vertical slating at each end with alternate courses of full width and slate-and-a-half or extra wide slates.
- 2 All corners and angles should be weathered with Code 3 lead soakers interlaced with the slates or with feature lead roll details.

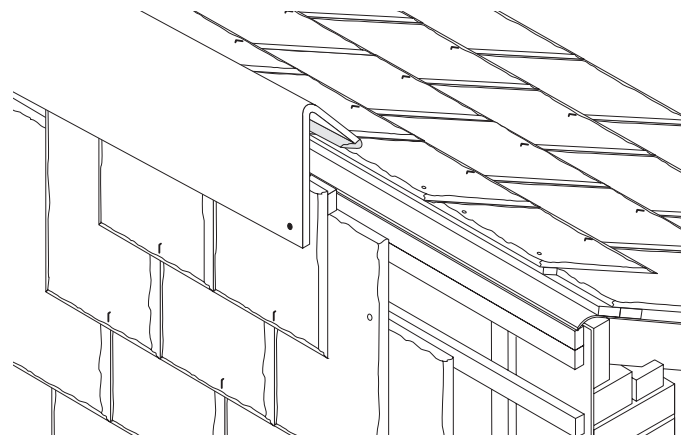

Fig. 30 Vertical slating with fibre cement mono-pitch ridge capping

- 3 The soakers for vertical slating are 200mm width, with length equal to gauge + lap + 20mm.
- 4 Junction of vertical slating with roof verge. Install an additional slating batten parallel to and below the roof verge.

Vertical slating

- 5 At the ends of the courses, mitre-cut the extra wide slates to the angle of the verge rake. Fix cut slates to the batten with the cut edge parallel to and below the verge (not illustrated).
- 6 When completing vertical to either horizontal eaves soffits or a mono pitch apex finish the slating as per finishing to ridges on page 25-26. The position of the fixings and the extra slate batten for these fixings of a mono pitch ridge unit is the same as for a fibre cement ridge on page 39-40.
- 7 If vertical slating is being installed as a ventilated rainscreen or requires a ventilated batten cavity, please contact Technical for details.

CEDRAL CLICK TRIMS

In some circumstances for vertical slating, we recommend the use Cedral Click profiles for corners and abutment stops. It may also be possible to use the Cedral lintel profile. These products will all accommodate and protect cut slate edges.

Please contact our Technical Department on 01283 501505 for further information.



Ventilation guidance

- 53 Standards and regulations
- 54 Control of condensation
- 56 Underlays
- 58 Types of roofs
- 61 Cold roofs
- 65 Warm roofs

Standards and regulations



BS 5250

Detailed information on methods to control harmful condensation is given in British Standard BS 5250: 'Code of practice for control of condensation in buildings', Section 8.4 'Roofs'.



APPROVED DOCUMENT C

Approved Document C 'Site preparation and resistance to moisture' contains information relating to 'Roofs (resistance to damage from interstitial condensation)' and 'Roofs (resistance to surface condensation and mould growth)' in Part 6.



APPROVED DOCUMENT F1

The relevant document is Approved Document Part F1 'Means of ventilation'.

Designers should consider the position of terminals to ventilation systems when designing the roof. Approved Document F1 states that there shall be adequate ventilation provided for people in the building. It does not apply to a building or space within a building into which people do not normally go, or which is used solely for storage, or a garage used solely in connection with a single dwelling.

Control of condensation

Condensation in roof spaces has become more of a problem with the increase in highly insulated buildings. Moreover, changes in life style have led to higher levels of water vapour in modern buildings. This water vapour naturally ascends to the roof space, where it condenses on contact with cooler surfaces. Further condensation is likely to be caused by climatic conditions, and may eventually result in timber rot, metal corrosion and damage to insulation and fittings.

Approved Document C states: '6.10 A roof will meet the requirements if it is designed and constructed in accordance with clause 8.4 of BS 5250 and BS EN ISO 13788.'

Detailed information on methods to control harmful condensation is given in British Standard BS 5250: 'Code of practice for control of condensation in buildings' Section 8.4 'Roofs'. Prevention of condensation in roof voids is best achieved by the provision of natural air ventilation.

BS 5250 states that the designer should take account of the following moisture sources in buildings:

- Water incorporated during the construction process (including precipitation)
- Precipitation after construction
- Water vapour arising from the occupants and their activities
- Temporary condensation occurring when cold weather conditions are followed by warm, humid weather

Control of condensation

SEALED CEILINGS

BS 5250 emphasises the importance of well-sealed ceilings as a means to curb the transfer of moisture into a roof space by means of moisture laden air. This means:

- The avoidance of gaps and holes in a ceiling
- The siting of access doors or hatches into the roofspace away from moisture producing areas such as bathrooms or kitchens
- That hatch covers must be effectively sealed
- High levels of workmanship

AIRTIGHTNESS OF CEILINGS

Air leakage through gaps in a ceiling transfers more heat and moisture into the roof by convection than passes through the ceiling materials by diffusion.

Sealing the ceiling is therefore an essential requirement when considering the design of the roof envelope.

Key design issues to consider are as follows:

- Avoid construction gaps
- Avoid roof access doors or hatches in rooms that produce excessive moisture
- Use a sealed loft hatch and frame to BS EN 13141-1
- Seal all services and rooflights
- Use recessed light fittings rated IP60 to IP65 to BS EN 60529
- Seal the head of cavity walls to prevent transfer of warm moist air into the loft

Underlays

The British Standard recognises two types of underlay.

- LR underlay: water vapour resistance of $< 0.25\text{MN},\text{s/g}$
- HR underlay: water vapour resistance of $> 0.25\text{MN},\text{s/g}$

When considering the choice of underlay, the designer must consider the system as a whole, including the vapour resistance of other elements such as plywood, chipboard, etc.

Generally speaking, the lower water vapour resistance levels of LR underlays, mean increased capacity to reduce condensation by allowing more water vapour to pass through.

The use of a vapour-permeable underlay may also assist in the dispersion of moisture-laden air. However, as this air is discharged into the batten/counterbatten space, it is important that this void is also effectively ventilated. It is recommended that designers should undertake a Condensation Risk Analysis in accordance with BS 5250 to determine the level of ventilation required.

Underlays

FULLY BREATHABLE UNDERLAYS

The British Standard mainly distinguishes between two types of underlay: high resistance (HR) impermeable and low resistance (LR) vapour permeable. However, there are some manufacturers of low resistance underlays that claim their products are fully breathable, negating the requirement for ventilation as set out in the British Standard.

There are a number of factors to consider before using any type of low resistance underlay, including:

1. How well the ceiling is sealed
2. Whether a close-fitting roof covering is being used
3. Obstructions in the roof space

In all circumstances, Cedral recommend the use of additional ventilation when using any type of low resistance underlay with their Cedral fibre cement slates.

25mm thick counter battens are required on each rafter over the breather membrane and then the slate battens are fixed onto these counter battens.

This batten cavity is ventilated using 25mm over fascia units at the eaves, which are placed over the breathable underlay and provide $5,000\text{mm}^2/\text{m}$ either side of the ridge using a dry ridge system.

Any ventilation that is required below the roofing underlay is provided via the soffits at low level and via an in-line ventilator at high level.

Roof types

BS 5250 discusses three roof types:

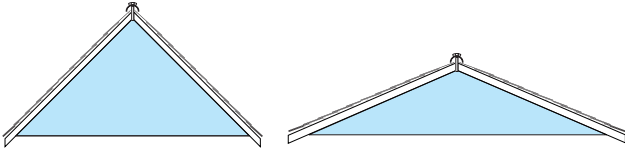

1. ROOFS WITH A LARGE VOID ABOVE INSULATION

Where insulation is at ceiling level and the void is therefore uninhabited and 'cold'. Here, problems with condensation can be minimised provided that there is adequate provision for ventilation, which BS 5250 specifies as:

- 25mm along the length of the eaves for pitches of 15° or less
- 10mm along the length of the eaves for pitches of more than 15°
- Additional continuous 5mm ventilation at high level for roofs where pitch exceeds 30°, or for roofs of any pitch with a span of more than 10m, or lean-to or mono-pitch roofs

Notes on roof types 1, 2 and 3 for 'cold' and 'warm' roofs

- If it is not possible to use ridge ventilators or eaves ventilators because of the detailing of the roof, in-line ventilators should be used
- The clear ventilation path from the interior of the roof to the exterior must always be designed so that it does not compromise the weatherproof function of either the underlay or the roof covering
- All ventilation openings should be fitted with a screen or grille to help prevent the ingress of rain, snow, birds and large insects, but the holes in the grille should be not less than 4mm in diameter to prevent excessive airflow resistance

Roof types

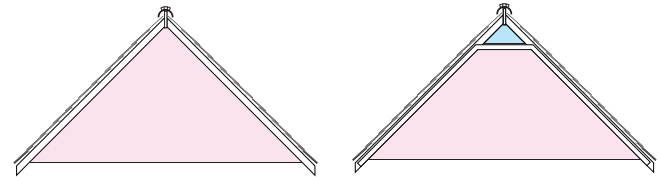

2. ROOFS WITH A SMALL OR NO VOID ABOVE INSULATION

Where the insulation follows the line of the rafters, often creating a habitable space, or 'warm' roof. Problems with condensation can be minimised by elimination of gaps in the insulation and providing a well sealed ceiling. BS 5250 specifies adequate provision for ventilation for these types of roof as:

- Low level openings should be equivalent in area to a continuous opening of not less than 25mm along the length of all the eaves
- High level openings should be equivalent to a continuous opening of not less than 5mm along the length of the ridge or hip

Roof types

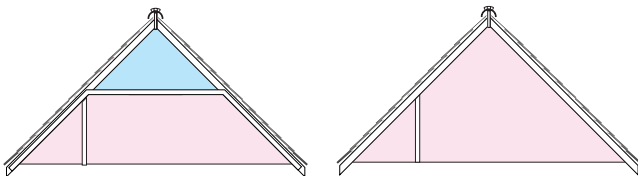

3. TILED AND SLATED ROOFS CONTAINING ROOMS

These should be ventilated as 2, opposite, but if an obstruction to a ventilation path occurs, such as fire separating walls, additional ventilation openings should be provided.

- Immediately below the obstruction equivalent to 5mm along the length of the obstruction
- Immediately above the obstruction equivalent to 25mm along the length of the obstruction

Cold roofs

In a 'cold roof', the most common form of roof construction, the insulation is laid at ceiling joist level, leaving the roof space relatively colder than the accommodation below.

To comply with Approved Document C and BS 5250, free airspace should be provided at both eaves and/or ridge level to ensure that effective through-ventilation of the whole roof is achieved, and thereby to assist in the control of condensation.

The following illustrations suggest the correct positioning of vents and the precise amount of free airspace required for 'cold roof' construction in accordance with Approved Document C and BS 5250.

VENTILATION OPTIONS

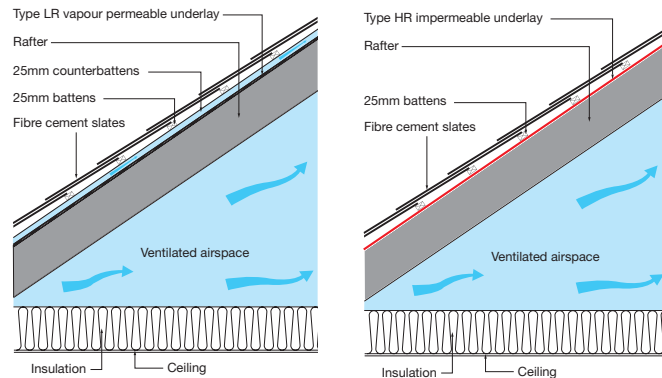

Key to illustrations

- Cold roof/building areas
- Low Resistance underlay
- High Resistance underlay

Cold roofs

NORMAL CEILING

A ceiling where no attempt has been made to seal all gaps or penetrations (e.g. light drops, pipes etc.)

WELL-SEALED CEILING

The design avoids construction gaps, especially at the wall ceiling junction with dry lining construction and holes in the ceiling.

No access door or hatch should be located in rooms where large amounts of moisture are produced, including kitchens or bathrooms.

The ceiling is sealed to the external walls to limit any leakage through cracks. The head of all cavities in the external walls, party walls and partition walls is sealed to prevent transfer of warm, moist air into the loft.

CLOSE-FITTING COVERINGS (CEDRAL FIBRE CEMENT SLATES)

When specifying a close-fitting covering which is relatively airtight (such as Cedral fibre cement slates) with an LR underlay, there is a risk of interstitial condensation forming on the underside of the underlay and the external covering.

To avoid this risk, the batten space should be ventilated in accordance with BS 5250 using counter battens.

Cold roofs with a 'normal' ceiling

VAPOUR PERMEABLE UNDERLAYS (LOW RESISTANCE)

A low resistance underlay can reduce the requirement for ventilating the roof space. On fully boarded roofs, i.e. sarking, low resistance underlays should be treated as impermeable and the roof space below ventilated in accordance with the high resistance underlay requirements described above.

Where a close-fitting roof covering has been used, the batten spacing should be ventilated in accordance with BS 5250 using counter battens.

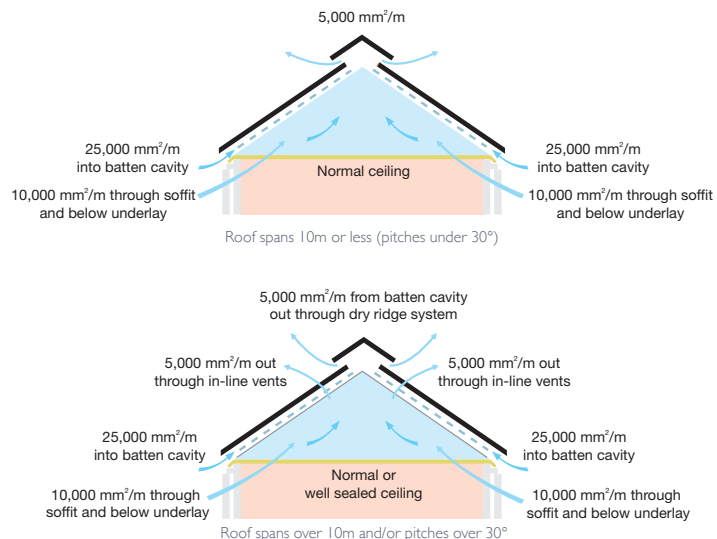

Cold roofs with a 'normal' ceiling

BITUMINOUS FELTS AND VAPOUR IMPERMEABLE UNDERLAYS (HIGH RESISTANCE)

Ventilation of the loft space under a traditional bituminous felt or non-vapour permeable underlay has proven to be an effective and robust solution when used with suitable high and low level ventilation.

No requirement to ventilate batten cavity.

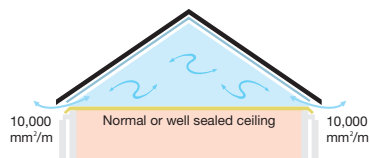

Roof spans under 10m (pitches under 30°)

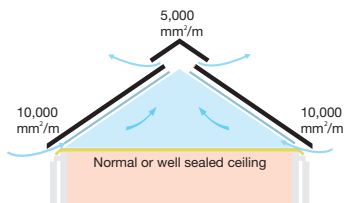

Roof spans over 10m (or pitches over 30°)

Warm roofs

In a 'warm roof', the insulation can be laid above, between or below rafter level, or in a combination of all these positions. This form of construction is generally chosen when the roof space is to be used for habitation.

Even though there is less risk of condensation with 'warm roof' construction, it is practically impossible to seal all joints, gaps and penetrations against all water vapour transmission, and it is therefore recommended that 'warm' roofs be ventilated at high and low level to comply with Approved Document C and BS 5250.

The following illustrations suggest the correct positioning of vents and the precise amount of free airspace required for three types of 'warm roof' construction in accordance with BS 5250.



Warm roofs

VENTILATION OPTIONS

No void above insulation and a type LR underlay

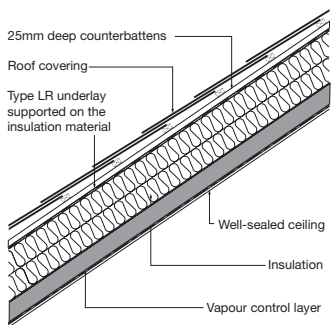

Small void above insulation and a type HR underlay

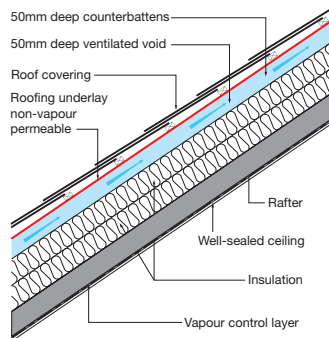

Key to illustrations

■ Cold roof/building areas

■ Low Resistance underlay

— Sarking

■ High Resistance underlay

WARM PITCHED ROOF WITH LR UNDERLAY

In warm pitched roofs with LR underlay, an AVCL should be provided at the ceiling line.

If the external covering is sufficiently permeable, it will allow vapour to be released and no ventilation of the batten space is recommended.

If it is not practicable to provide an AVCL, there might be some risk of interstitial condensation forming on the underside of the underlay. To avoid the risk, ventilated voids should be provided.

Warm roofs

CLOSE-FITTING COVERINGS

CEDRAL FIBRE CEMENT SLATES

When specifying a close-fitting covering which is relatively airtight (such as Cedral fibre cement slates) with an LR underlay, there is a risk of interstitial condensation forming on the underside of the underlay and the external covering. To avoid this risk, the batten space should be ventilated in accordance with BS 5250 using counter battens.

FULLY BREATHABLE UNDERLAYS

The British Standard mainly distinguishes between two types of underlay: high resistance (HR) impermeable and low resistance (LR) vapour permeable. However, there are some manufacturers of low resistance underlays that claim their products are fully breathable, negating the requirement for ventilation as set out in the British Standard.

There are a number of factors to consider before using any type of low resistance underlay, including:

1. How well the ceiling is sealed
2. Whether a close-fitting roof covering is being used
3. Obstructions in the roof space

In all circumstances, Cedral recommend the use of additional ventilation when using any type of low resistance underlay.

This can be achieved through the use of ventilated eaves and ventilated ridge systems or in-line ventilators (see page 57).

Warm roofs with an Air and Vapour Control Layer (AVCL)

VAPOUR PERMEABLE UNDERLAYS (LOW RESISTANCE)

Where an AVCL has been installed, the harmful effects caused by condensation can be controlled by the use of a vapour permeable underlay without ventilation. The vapour permeable underlay may be laid fully supported on the insulation or draped unsupported.

An AVCL is essential on the warm side of the insulation. If there is any doubt about the ability to provide and maintain an effectively sealed AVCL, then ventilation should be provided as if the underlay were impermeable.

The batten cavity must be ventilated.

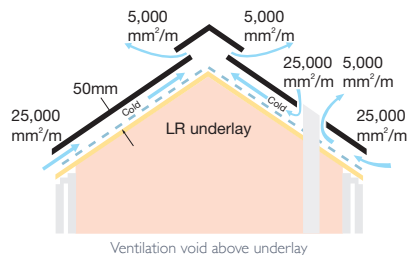

Any ventilation below the roof underlay will need to be through the soffit or via in-line slate ventilators.

Warm roofs with an Air and Vapour Control Layer (AVCL)

BITUMINOUS FELTS AND VAPOUR IMPERMEABLE UNDERLAYS (HIGH RESISTANCE)

The ventilation requirements for cold roofs with vapour impermeable underlays and 'well-sealed ceilings' are the same as for those without. Installing a 'well-sealed ceiling' will make the roof more energy efficient because airtightness will have prevented heat loss through convection. Heat loss due to low speed air currents over the cold side of the insulation (caused by ventilation) is negligible.

No requirement to ventilate batten cavity.

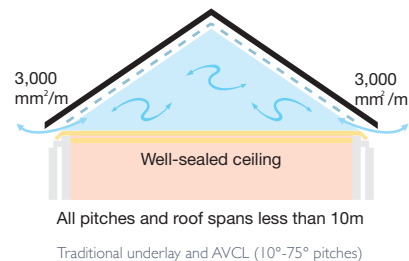

Notes

CEDRAL



The World of Roofs



more at cedral.world

Tel 01283 501505 Email techuk@etexgroup.com

Etex (Exteriors) UK, Wellington Road, Burton-upon-Trent, Staffordshire DE14 2AP

March 2021